

NOM: \_\_\_\_\_

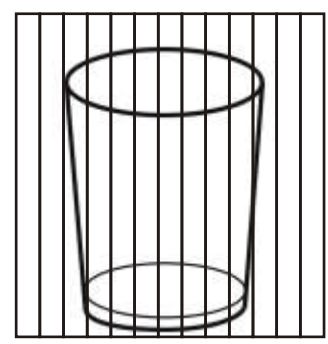

ENCERCLA ELS QUE SON IGUALS QUE EL PRIMER

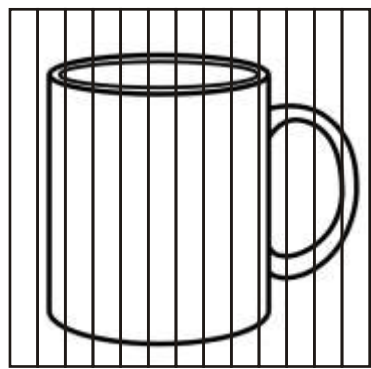
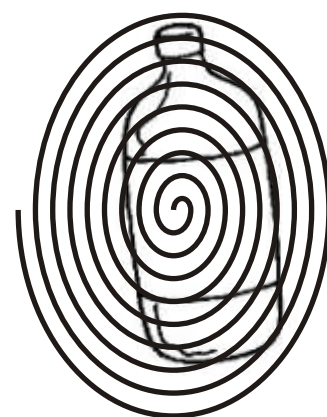
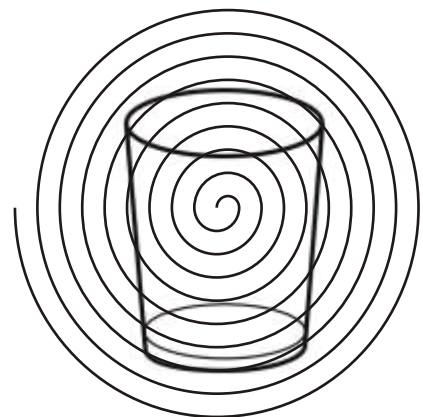
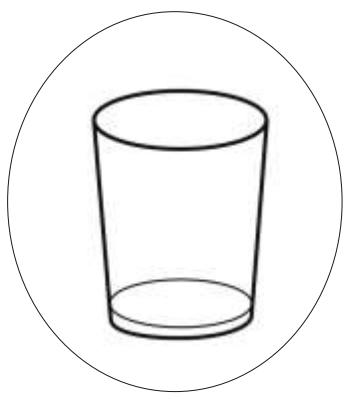

NOM: \_\_\_\_\_



ENCERCLA ELS QUE SON IGUALS QUE EL PRIMER

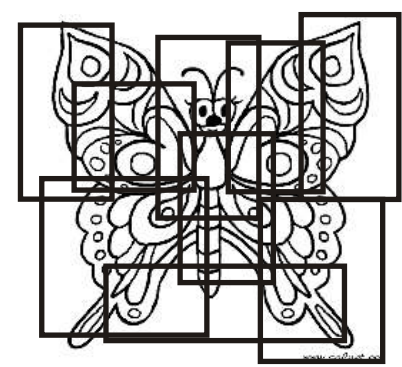
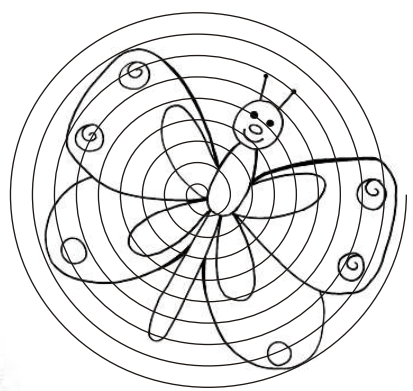
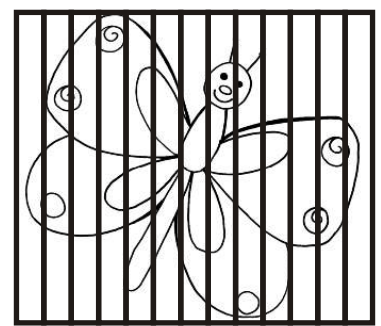
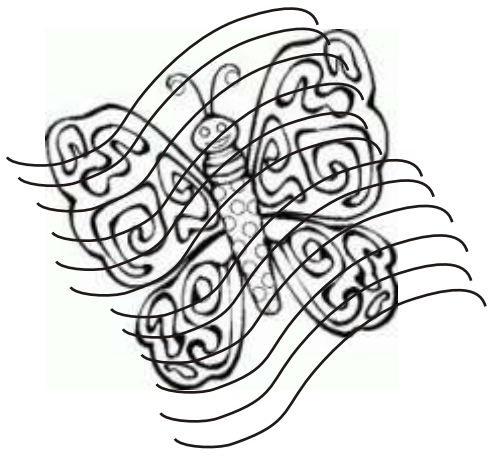
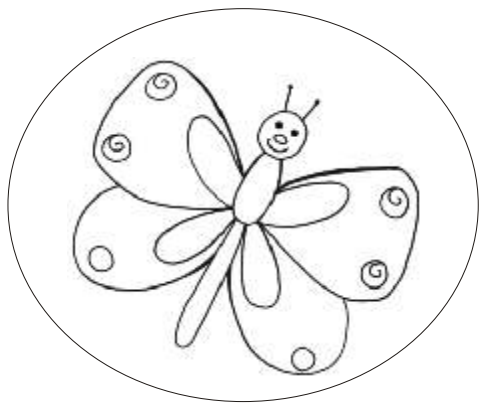

NOM: \_\_\_\_\_



ENCERCLA ELS QUE SON IGUALS QUE EL PRIMER

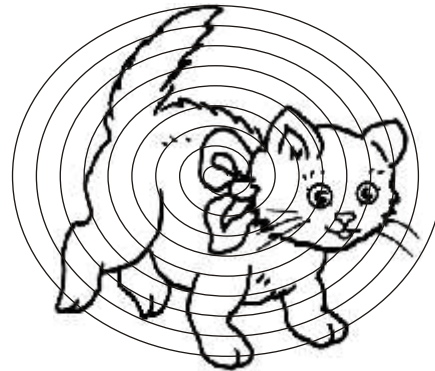
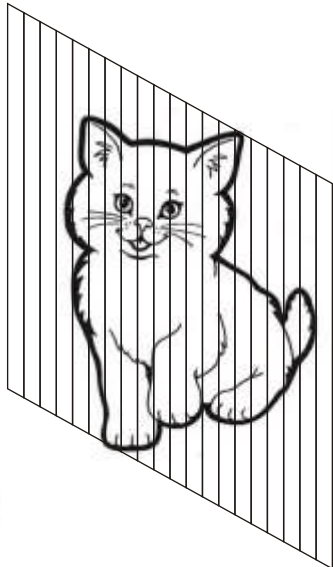
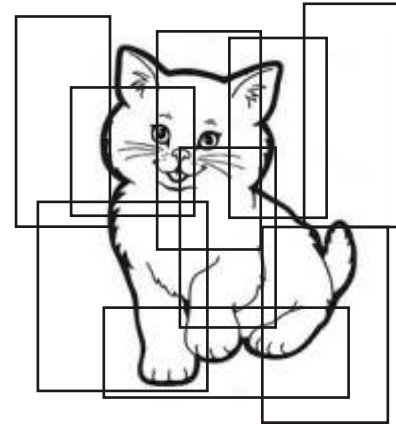

NOM: \_\_\_\_\_



ENCERCLA ELS QUE SON IGUALS QUE EL PRIMER

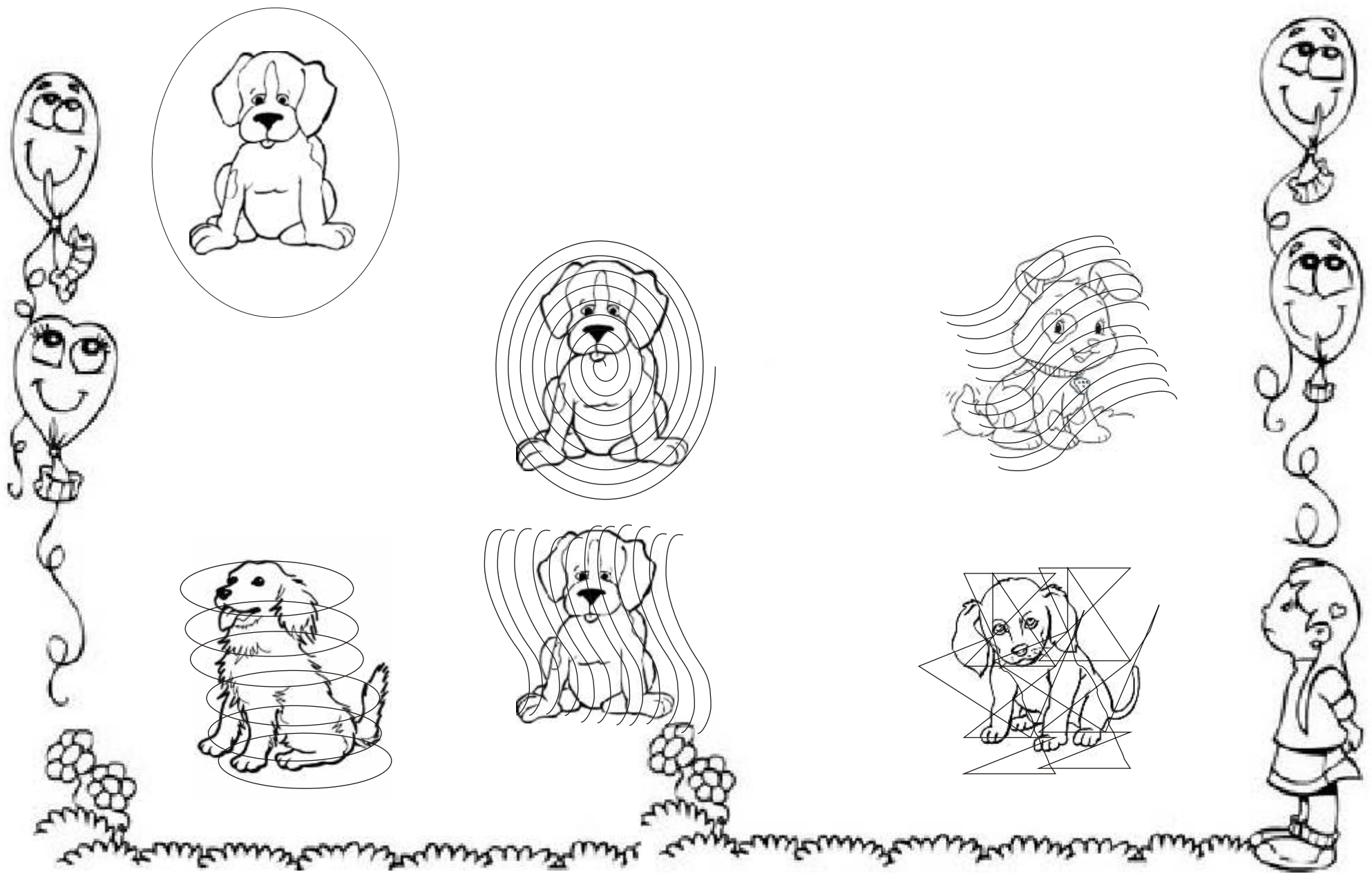

NOM: \_\_\_\_\_



ENCERCLA ELS QUE SON IGUALS QUE EL PRIMER



NOM: \_\_\_\_\_



ENCERCLA ELS QUE SON IGUALS QUE EL PRIMER

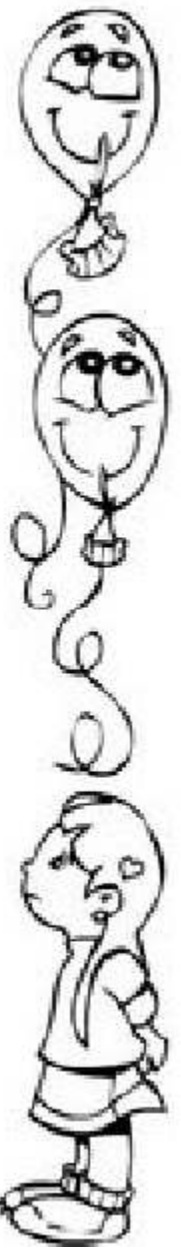
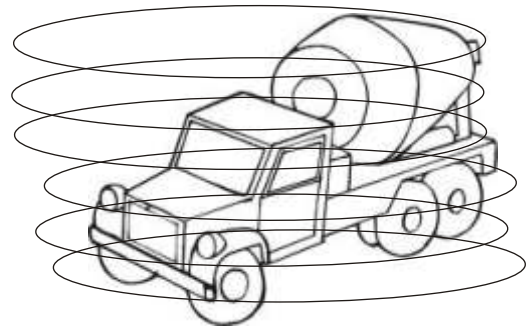
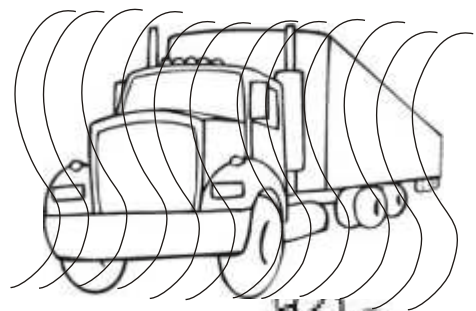
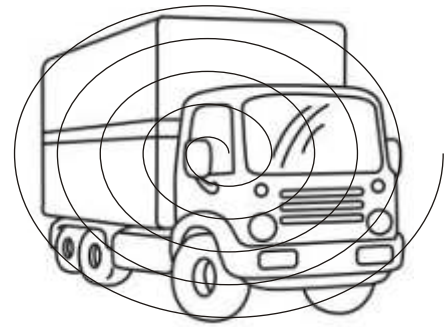
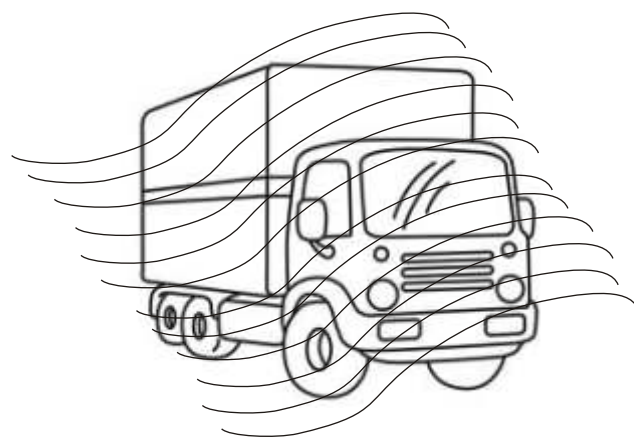
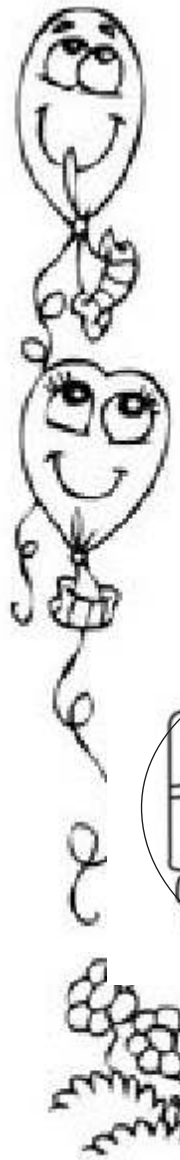

NOM: \_\_\_\_\_



ENCERCLA ELS QUE SON IGUALS QUE EL PRIMER

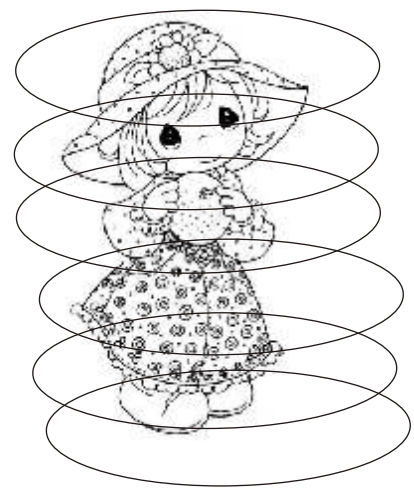
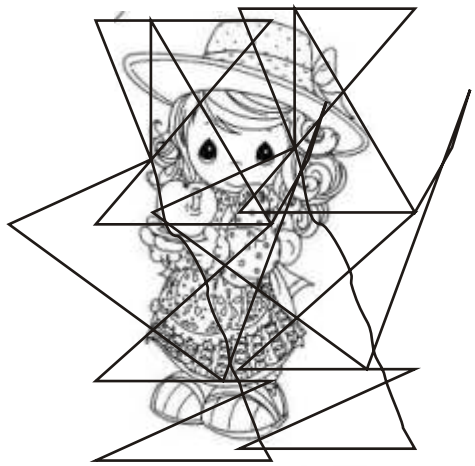

NOM: \_\_\_\_\_



ENCERCLA ELS QUE SON IGUALS QUE EL PRIMER



NOM: \_\_\_\_\_



ENCERCLA ELS QUE SON IGUALS QUE EL PRIMER

The page contains several cartoon illustrations arranged in a border and in the center. The first illustration is a smiling balloon with a face and a string. Other illustrations include a girl in a pointed hat, a boy with a large nose, a girl with a large nose, a boy with a large nose, a girl with a large nose, a boy with a large nose, a girl with a large nose, and a boy with a large nose. Some illustrations are circled, some are crossed out with a large 'X', and some are surrounded by wavy lines.

NOM: \_\_\_\_\_



ENCERCLA ELS QUE SON IGUALS QUE EL PRIMER

